

***Indonesia's experience on the use of  
Accreditation as a basis for conformity  
assessment acceptance***

**Geneve, 12 November 2019**

# Indonesia System on Standardization and Conformity Assessment (Act no 20 year 2014)

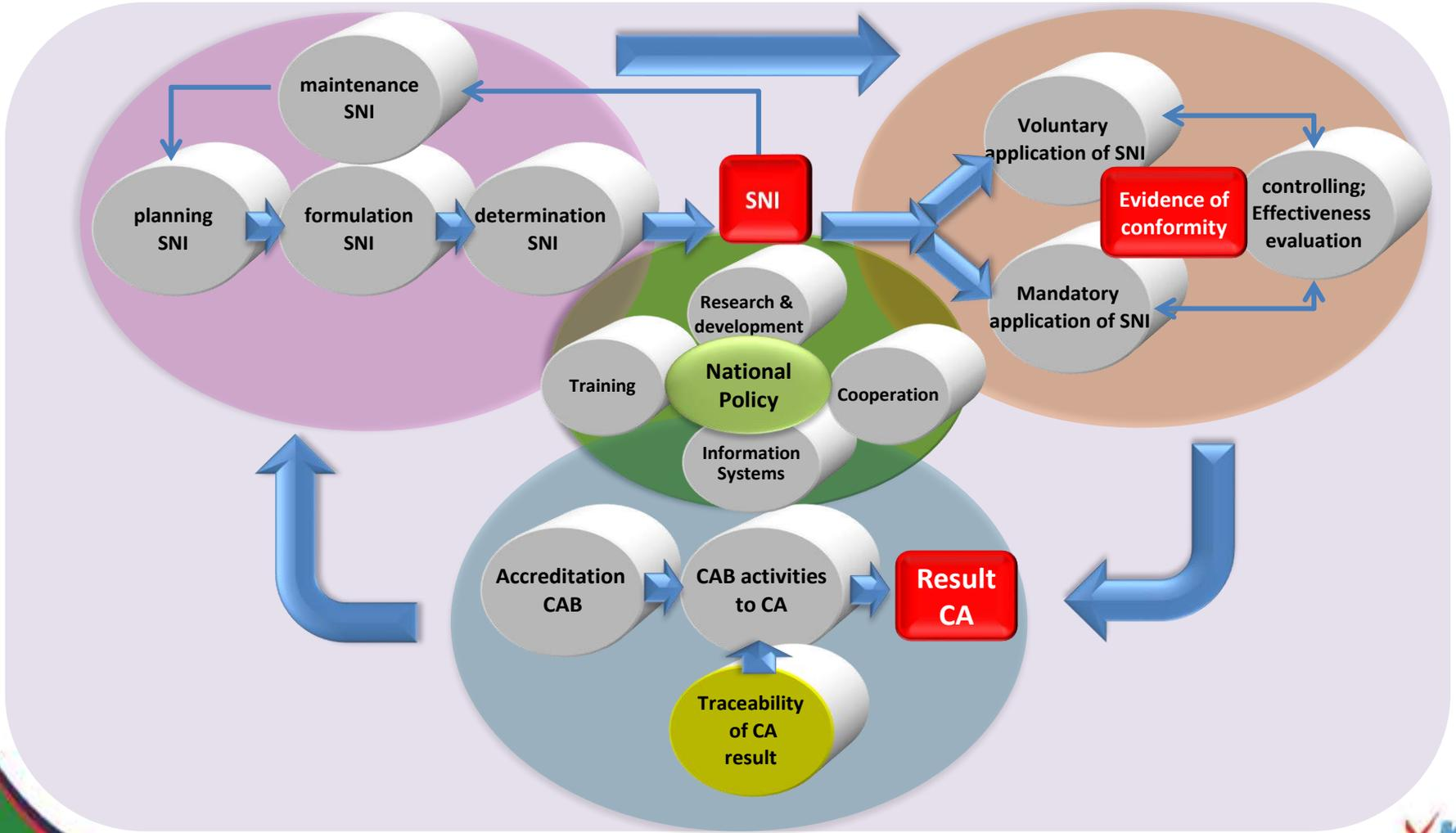

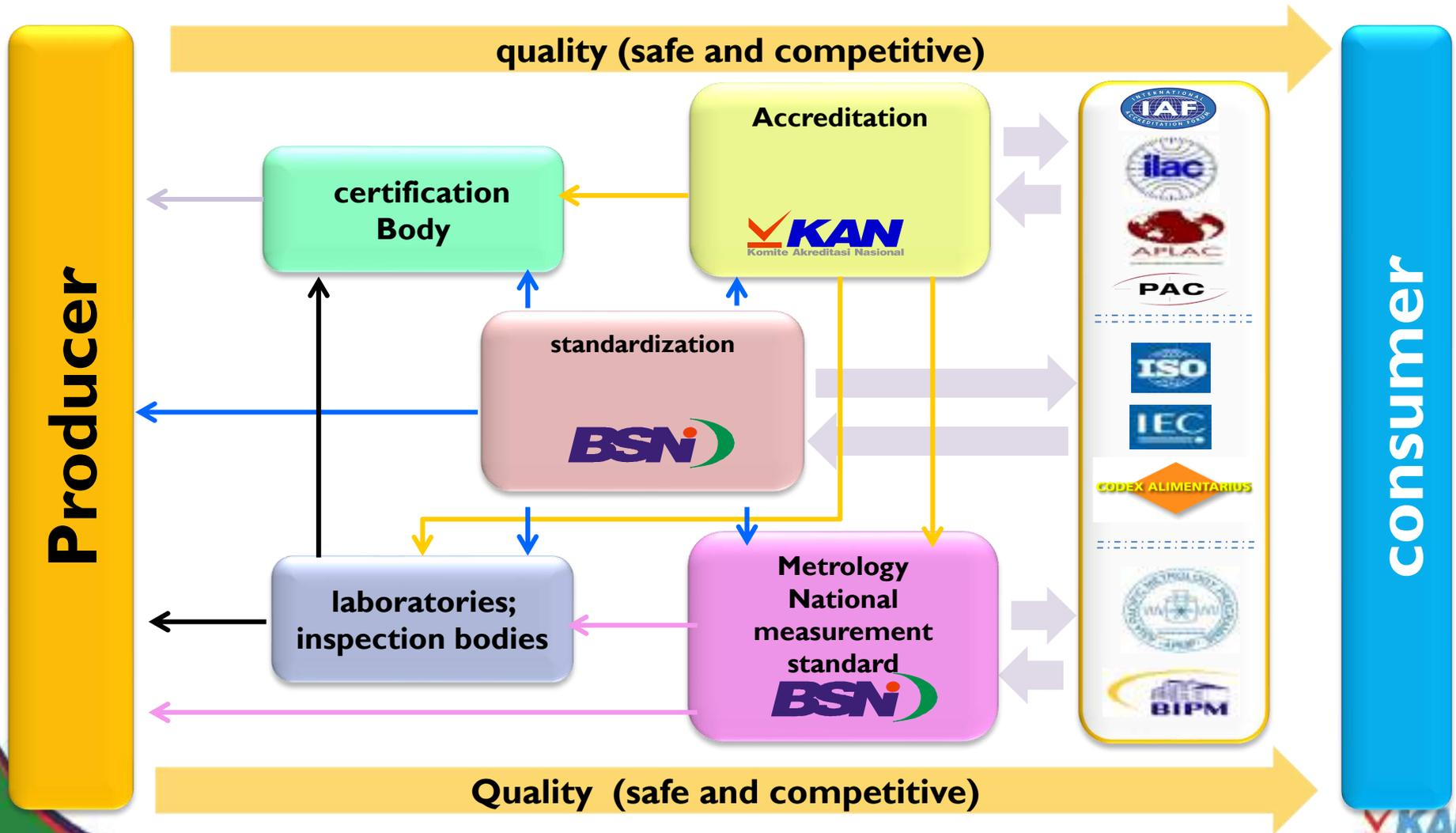

# KAN - ACCREDITATION AND CERTIFICATION SYSTEM

## KOMITE AKREDITASI NASIONAL (KAN)

(ISO/IEC 17011)

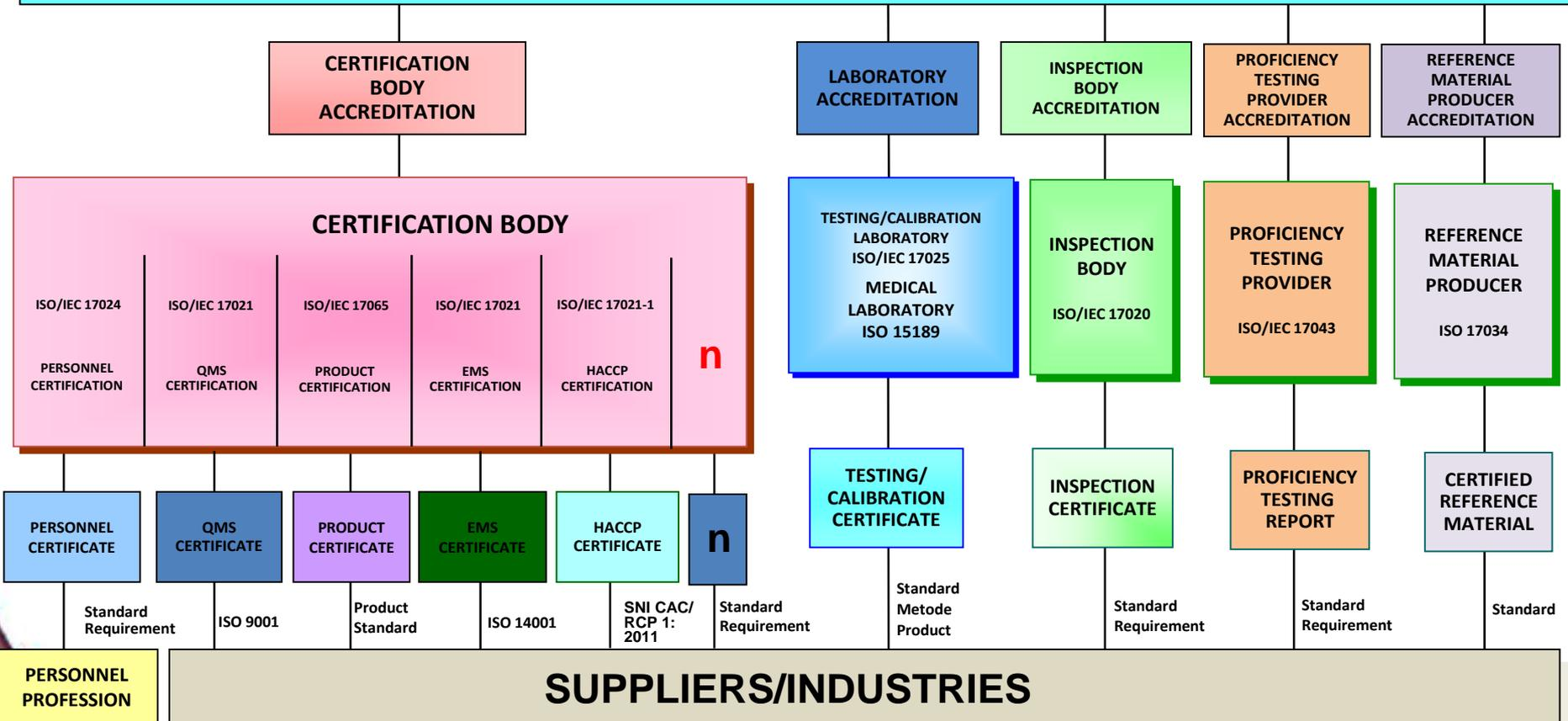

# (n) Accreditation Schemes

- *Ecolabel (KAN Guide 801)*
- *Food Safety ISO 22000*
- *Organic Foods (ISO IEC 17065, KAN Guide 901)*
- *Sustainable Forest Management (ISO/IEC 17021)*
- *Timber Legality (ISO/IEC 17065)*
- *Information Security Management System (ISO/IEC 17021)*
- *Medical Devices Quality Management System CB (ISO/IEC 17021)*
- *Green House Gases Verification/Validation Body (ISO 14065)*
- *Energy Management System ISO 50001*
- *Supply Chain Management System ISO 28001*
- *Tourism (ISO 17021)*
- *Anti Bribery Management System ISO 37001*
- *Halal (ISO 17065)*
- *Travel provider of umrah (17021)*
- *Emisi GRK ICAO CORSIA (14065)*



## **APAC and ILAC MRA Signatory for :**

1. Testing Laboratory (ISO/IEC 17025)
2. Calibration Laboratory (ISO/IEC 17025)
3. Medical Laboratory (ISO 15189)
4. Inspection Body (ISO/IEC 17020)
5. Proficiency Testing Provider (ISO/IEC 17043)

## **APAC and IAF MLA Signatory for :**

1. QMS ISO 9001
2. EMS ISO 14001
3. Product Certification (ISO/IEC 17065)
4. FSMS ISO 22000
5. Person Certification (ISO/IEC 17024)
6. Energy Management System ISO 50001
7. Information Security Management System ISO 27001

Accreditation is a pre requisite requirements for conformity assessment procedure to recognize the compliance of regulated product with SNI (Indonesia National Standard) when adopted in the technical regulation, tourism business, umrah and halal scheme

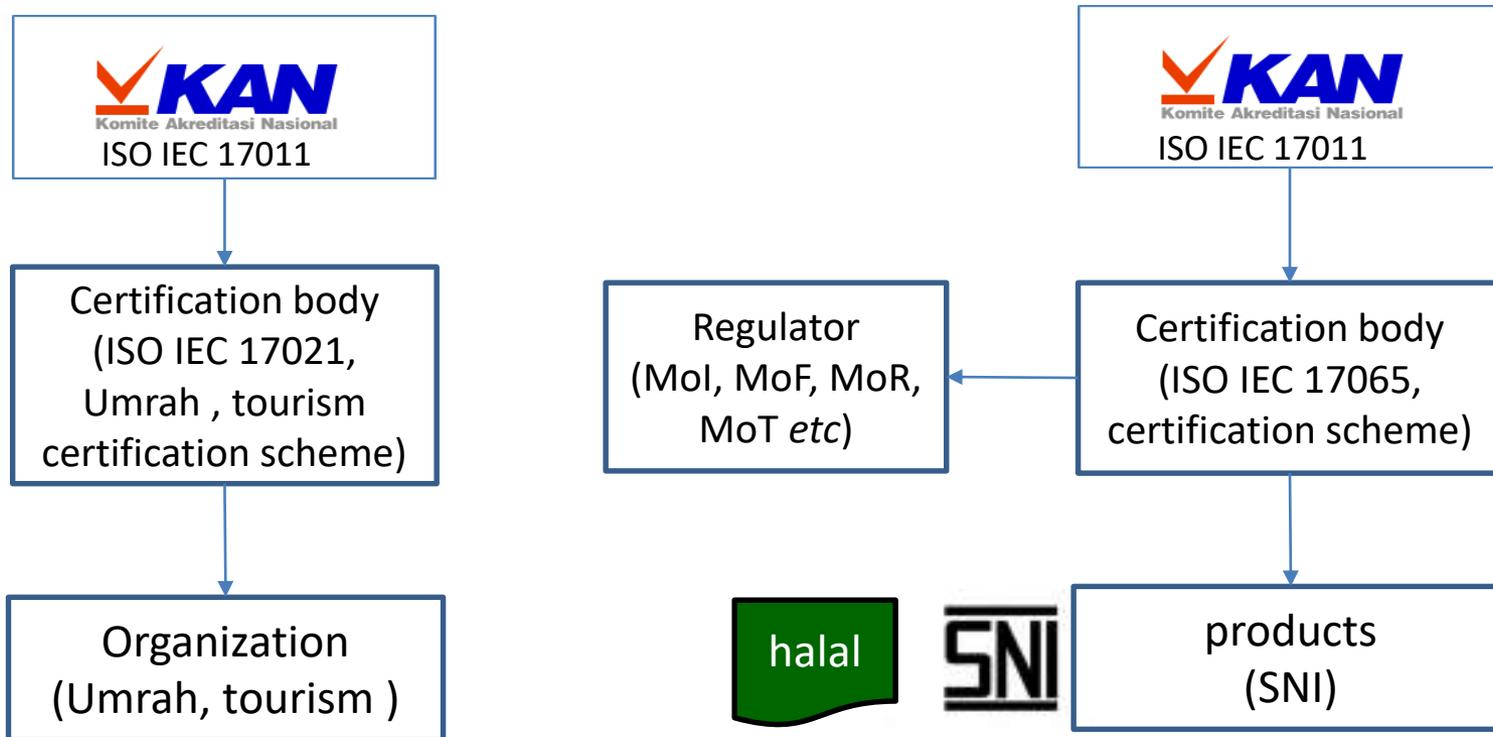



## Accreditation support in facilitating ASEAN cooperation



- **Mutual Recognition Arrangement**

To demonstrate the technical competence of the conformity, CAB shall be accredited by AB which is a signatory of regional or international MRA (APAC, IAF and ILAC)

→ **e.g : Electrical & Electronic Equipment**

the agreements allows a regulated EEE if tested by a listed testing laboratory and certified by a listed certification body in the exporting member country to be accepted by the importing member country without having undergo further testing and/or certification.

→ **e.g: Automotive**

mutual recognition on test report issued by accredited laboratory

# ASEAN MRA EE scheme

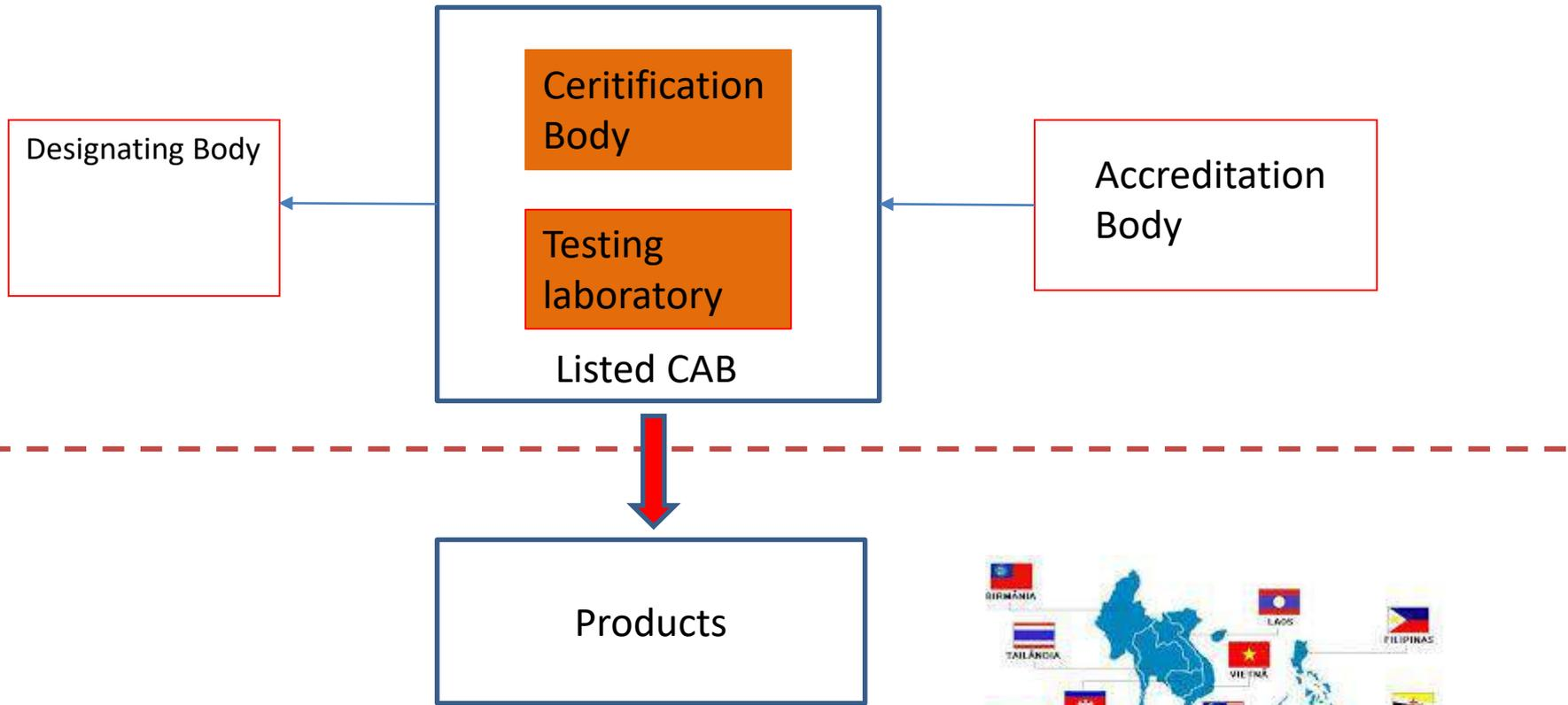

Free movement of goods  
Electrical and electronic



# MRA on Halal (Indonesia –UAE)

- MRA on Accreditation on halal certification body between Indonesia and UAE
- to facilitate exporters in recognition of halal certificate issued

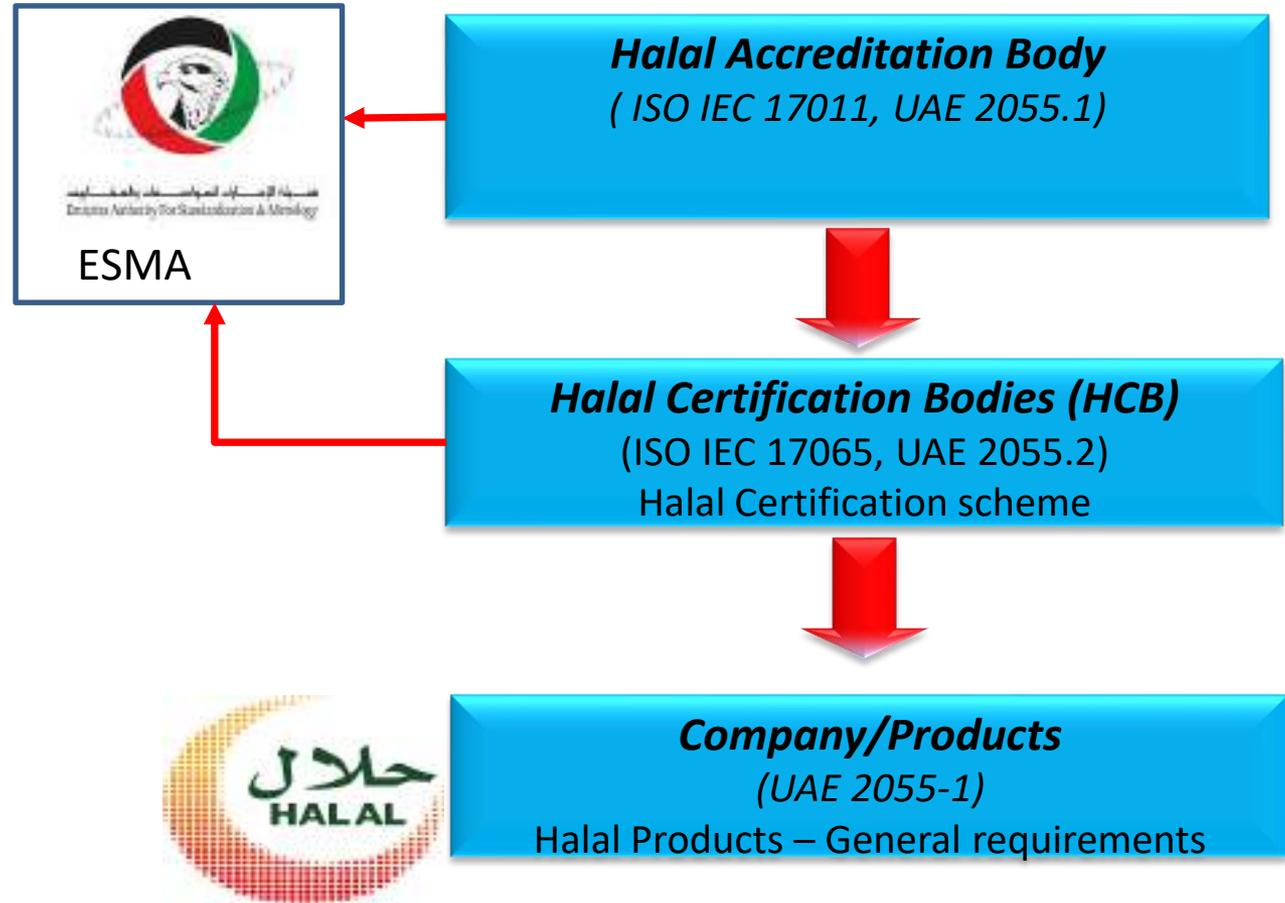

# FLEGT (Indonesia – EU)

- To facilitate Indonesia exporter of wood product to access EU market (EU FLEGT)
- Accreditation on verification body on timber legality and forest sustainability certification body in order to be FLEGT licensed

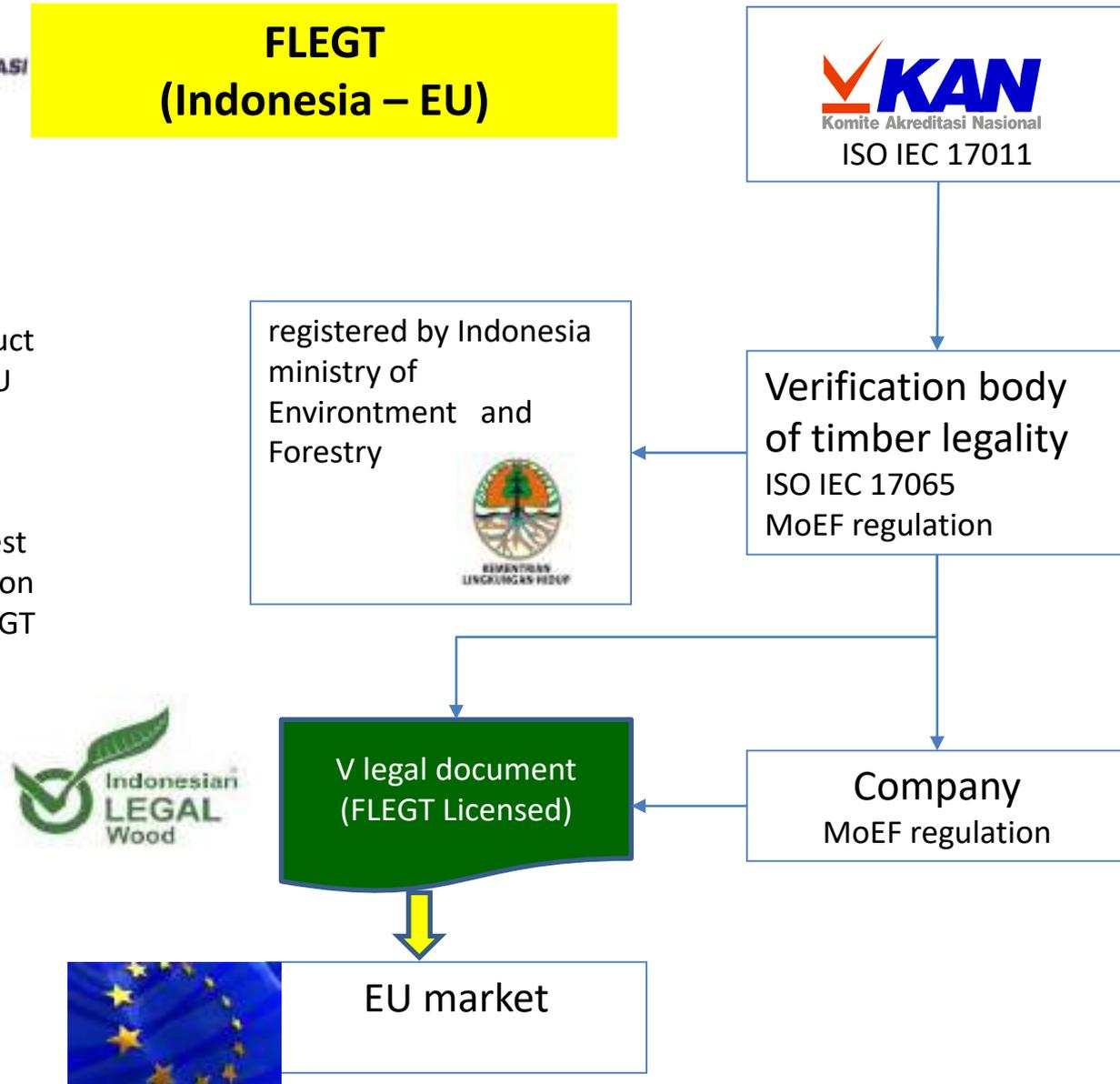

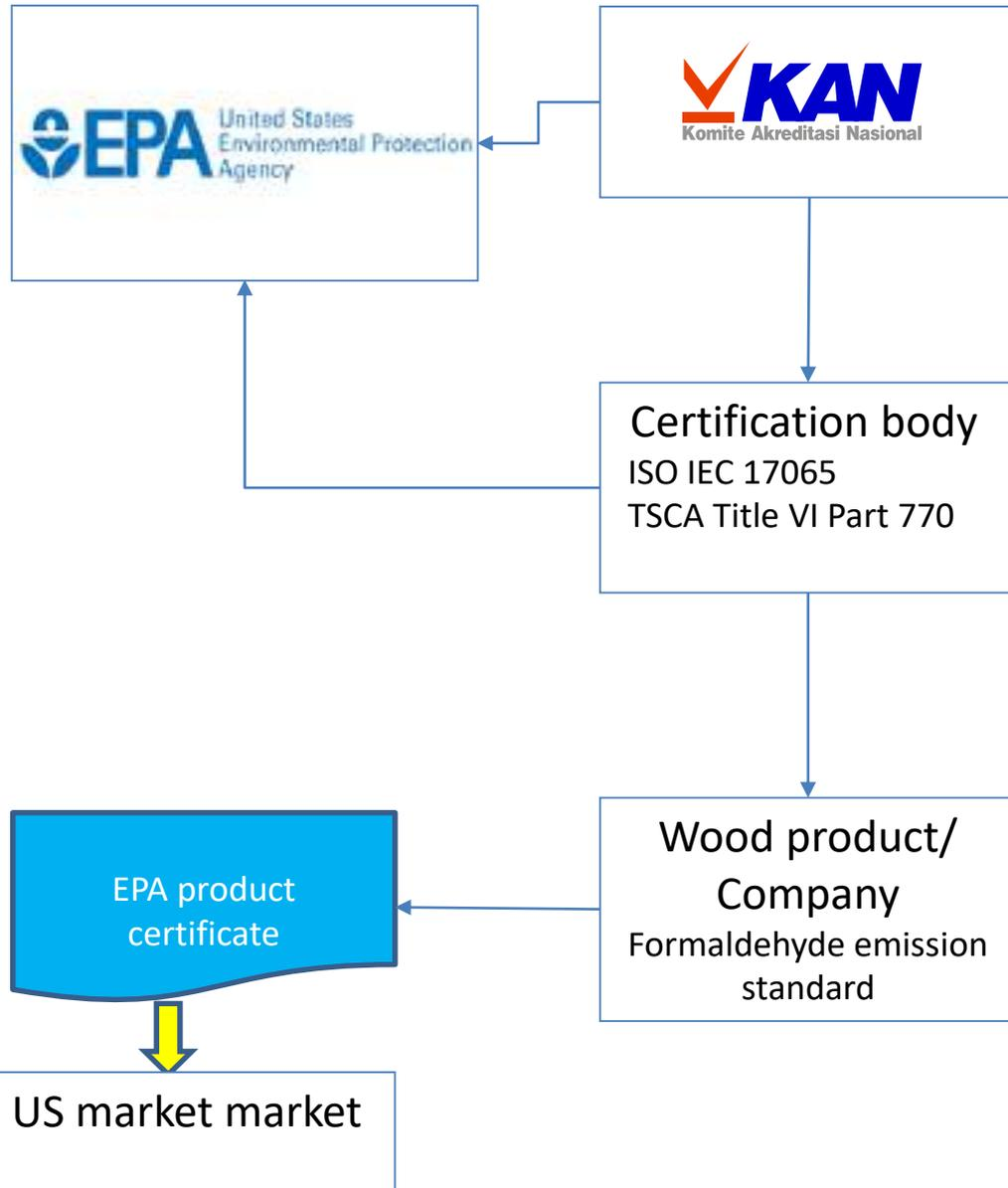

**MRA on wood product certification (Indonesia – US)**

- To facilitate Indonesia exporter of the recognition on the product certificate in ensuring the conformity with US Formaldehyde emission standard for wood product

- **Challenge**

- Lack of acceptance of the conformity assessment result which is under the framework of IAF ILAC MRA
- Some Private standard scheme do not recognize accreditation under the framework of IAF ILAC MRA

- **Conclusion**

- ❖ Accreditation is important to prove the confidence of conformity assessment result.
- ❖ Promoting the acceptance of accreditation under the framework of IAF ILAC MRA

# TERIMA KASIH THANK YOU



member of



member of



Bureau  
International des  
Poids et  
Mesures



[www.bsn.go.id](http://www.bsn.go.id)

[www.kan.or.id](http://www.kan.or.id)

# Overview of the system for accreditation in the EU as part of National Quality Infrastructure



12 November 2019, Geneva

[www.european-accreditation.org](http://www.european-accreditation.org)



# Regulator / Consumer Expectation

Products benefiting from the free movement of goods within the EU shall fulfil requirements providing a high level of protection of public interests such as

- ◆ Health and Safety in general,
- ◆ Health and Safety at the workplace,
- ◆ Protection of consumers,
- ◆ Protection of the environment and security.



# Market / Economy Expectation

The free movement of products shall not be restricted to any extent greater than that which is allowed under EU harmonisation legislation or any other relevant EU rules.



# Regulator / Consumer Expectation

- ◆ Who shall control conformity of the products with legislations and market needs?
- ◆ Public authorities (only)?
- ◆ Too many products to be controlled!
- ◆ Ensure public interest by controlling (assessing) the control bodies by public authorities.
- ◆ National Accreditation Bodies are the professionals in assessing control bodies.

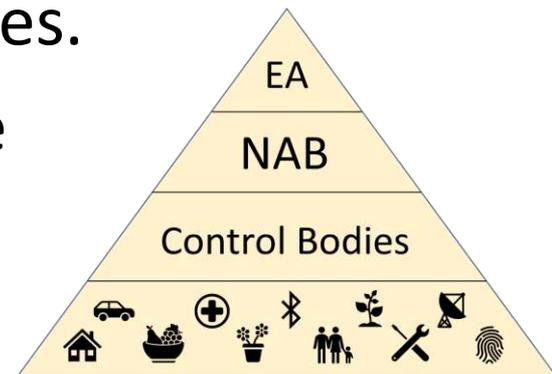

# European Accreditation System

## ◆ Regulation (EC) No 765/2008 on Accreditation

- A service of public interest
- Public authority
- Last level of control of conformity assessment
- One NAB per country
- Mandate of the government

- Voluntary and mandatory fields
- Full compliance with applicable rules
- Accountability to stakeholders
- Non-profit activity
- No competition

# European Accreditation System

## Definition of Accreditation (Regulation 765/2008)

Accreditation shall mean an attestation by a national accreditation body that a conformity assessment body meets the requirements set by harmonised standards and, where applicable, any additional requirements including those set out in relevant sectoral schemes, to carry out a specific conformity assessment activity.



# European Accreditation System

## Regulation (EC) No 765/2008 on Accreditation

- ◆ Strengthens the use of accreditation and the EA MLA as a basis for notification.
- ◆ Places an obligation on EU Member States to accept results issued by the conformity assessment bodies accredited by any of the EA MLA signatories.



# European Accreditation System

## Regulation (EC) No 765/2008 on Accreditation

- ◆ EA is appointed as the European Accreditation Infrastructure.
- ◆ Framework Partnership Agreement with the EC / EFTA.
- ◆ General Guidelines for the cooperation between EA, EC, EFTA and Competent National Authorities.



# European Accreditation System

## EA main tasks

- ◆ Peer evaluation of the National Accreditation Bodies
- ◆ Harmonization of accreditation throughout Europe
- ◆ Cooperation with and support of the European Commission and its Directorates-General





# EA Members

## EA Membership

- EU / EFTA
- EU Candidates
- ENP Countries



Google Maps

# EA Members

DPA, Albania		ESYD, Greece		NA, Norway	
AA, Austria		NAH, Hungary		PCA, Poland	
BELAC, Belgium		ISAC, Iceland		IPAC, Portugal	
BAS, Bulgaria		INAB, Ireland		RENAR, Romania	
HAA, Croatia		ACCREDIA, Italy		ATS, Serbia	
CYS-CYSAB, Cyprus		LATAK, Latvia		SNAS, Slovakia	
CAI, Czech Republic		LA, Lithuania		SA, Slovenia	
DANAK, Denmark		OLAS, Luxemburg		ENAC, Spain	
EAK, Estonia		IARM, Macedonia		SWEDAC, Sweden	
FINAS, Finland		NAB-Malta, Malta		SAS, Switzerland	
COFRAC, France		ATCG, Montenegro		TURKAK, Turkey	
DAkS, Germany		RvA, Netherlands		UKAS, UK	

# EA Members

ALGERAC, Algeria



ARMNAB, Armenia



AZAK, Azerbaijan



BSCA, Belarus



BATA, Bosnia &  
Herzegovina



EGAC, Egypt



GAC, Georgia



ISRAC, Israel



JAS-AU, Jordan



DAK, Kosovo



SEMAC, Morocco



MOLDAC, Moldova



TUNAC, Tunisia



NAAU, Ukraine



# EA Stakeholders

## ■ EA Advisory Board

- National European Authorities
- European Commission
- EFTA
- European conformity assessment bodies (Associations)
- [European metrology organisations](#)
- European industry, services and trade, including small and medium sized enterprises
- European consumers
- [European standardisation organisations](#)



# EA Recognized Stakeholders



# EU legislations

Around 100 EU legislations with reference to accreditation and/or conformity assessment, examples:

- EU Product legislations
- Regulation on organic production and labelling of organic products
- EU ETS Regulation on the verification of data and on the accreditation of verifiers
- Regulation on unmanned aircrafts (drones)
- EU Decision on Forensic service providers (laboratory activities)
- Cybersecurity Act
- General Data Protection Regulation



# Trade Agreements

## EA and accreditation in international trade (examples)



EU – Canada  
Comprehensive Economic and  
Trade Agreement (CETA)



EU – Japan  
Economic Partnership Agreement

# European Accreditation Infrastructure

- Evaluation of the functioning of accreditation in Europe

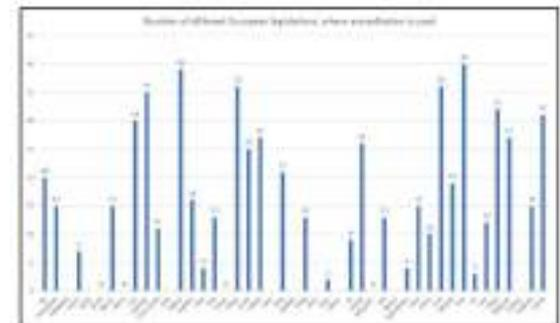
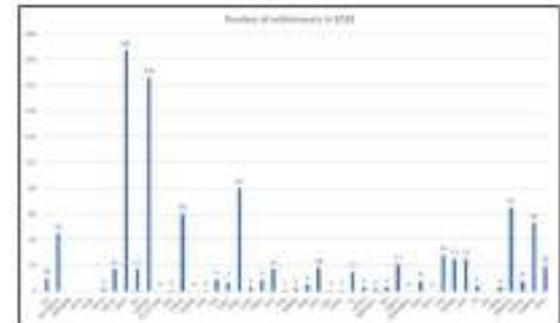
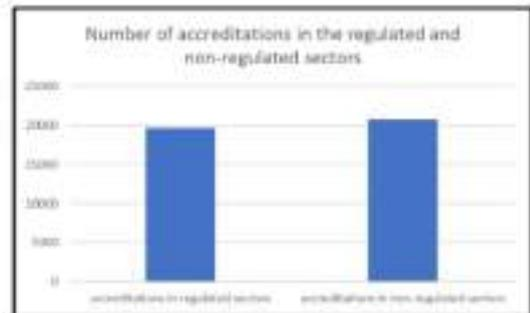
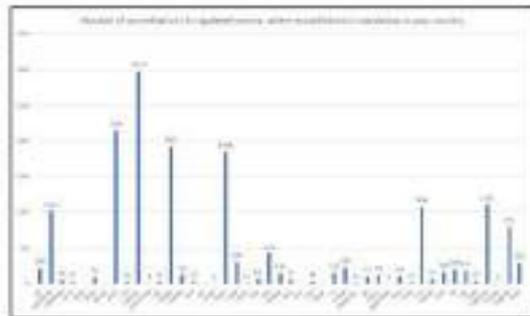



## EA

75 avenue Parmentier  
FR - 75544 Paris Cedex 11  
France

Phone: + 33 (0)1 40 21 24 -62

[secretariat@european-accreditation.org](mailto:secretariat@european-accreditation.org)

[www.european-accreditation.org](http://www.european-accreditation.org)

**FOR YOUR  
ATTENTION!**

**THANK YOU**

You want to learn more about  
EA and accreditation?  
Visit our website and consult  
our promotional materials:  
[http://www.european-  
accreditation.org/promotional-  
information](http://www.european-accreditation.org/promotional-information)

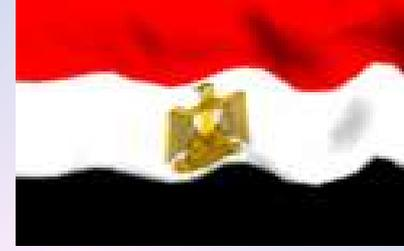

**Egyptian Accreditation Council EGAC**

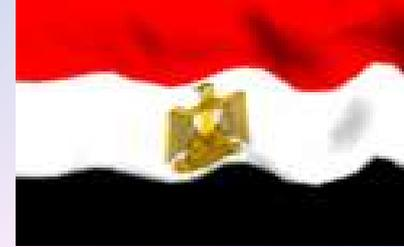

## **Brief about EGAC**

**EGAC was established in 1996 and reorganized in 2008 by presidential decrees**

**which granted the full independence technically, financially and administratively as the sole accreditation body in Egypt for assessment and accreditation of conformity assessment bodies**

**including testing, calibration and medical labs, inspection bodies, certification bodies for management systems, production and personnel besides proficiency testing providers.**

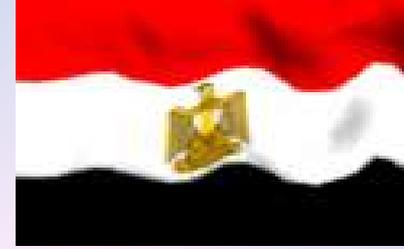

**EGAC achieved international recognition of  
ILAC in accreditation of testing / calibration  
and medical laboratories, and inspection  
bodies since 2009 and renewed in 2013, 2017  
till 2021.**

## Brief about EGAC

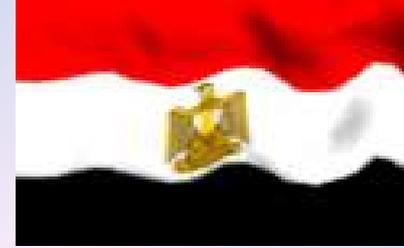

- EGAC achieved international recognition of IAF in accreditation of Certification Bodies of Management Systems including QMS and EMS since 2009 and renewed in 2013, 2017 till 2021 and extended its recognition to include FSMS in 2017.
- EGAC achieved AFRAC and ARAC recognition as recognized regional accreditation bodies in testing / calibration and medical laboratories, inspection bodies and accreditation of Certification Bodies of Management Systems including QMS and EMS and extended its recognition to include FSMS in 2017.
- EGAC is a member in Standards and Metrology Institute for the Islamic Countries (SMIIC) and in its Accreditation Council.

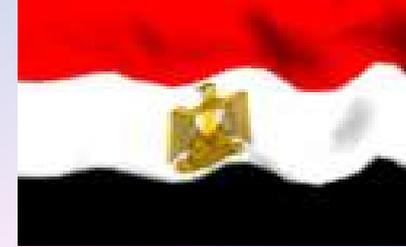

## Brief about EGAC (continue ...)

- EGAC signed BLA with European Cooperation for Accreditation EA in June 2019 in the scope of accreditation of PTP as the first accreditation body from the neighborhood countries to EU signs BLA in this scope.
- EGAC is a constituent member of International Halal Accreditation Forum IHAF and a member of its BOD and chairs the Technical Affairs Committee of IHAF.
- EGAC is a member of ISO Ad Hoc Group Anti-bribery management systems responsible for considering post-publication issues relating to ISO 37001:2016.
- EGAC is a Member of ISO Advisory Group Communications and Engagement responsible for addressing the immediate communications and engagement issues around ISO 37001.



## International Accreditation Recognition

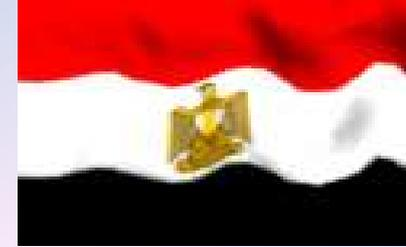

## Regional Accreditation Recognition



## International Halal Accreditation Forum



## Standards and Metrology Institute for the Islamic Countries



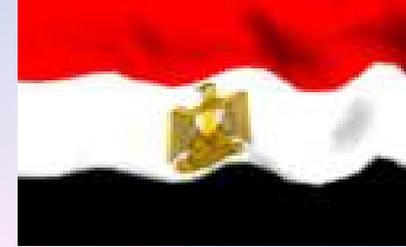

# Scopes of Accreditation

- Testing Labs ( ISO/IEC 17025 )
- Calibration Labs ( ISO/IEC 17025 )
- Medical Labs (ISO 15189 )
- Certification Bodies (QMS, EMS and FSMS) (ISO /IEC 17021)
- Inspection Bodies ( ISO/IEC 17020 )
- Persons Certification (ISO/IEC 17024)
- Product Certification (ISO/IEC 17065)
- Proficiency Testing Providers (ISO/IEC 17043)



# Accreditation Process

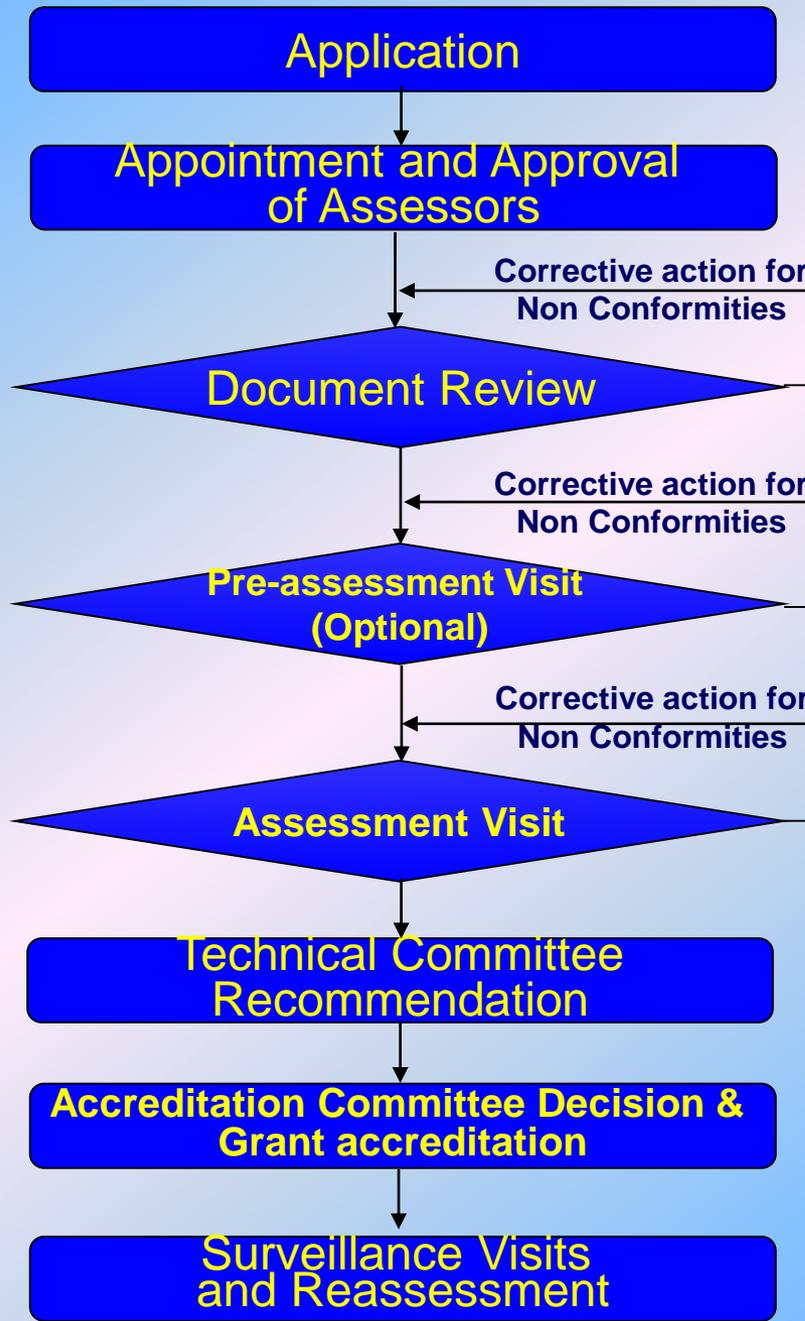
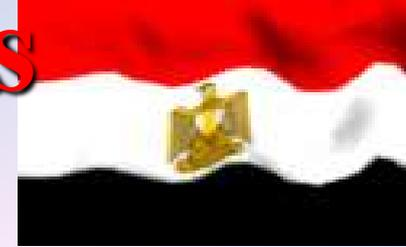

## البنية التحتية للجودة المصرية Infrastructure of Egyptian Quality System



• الهيئة  
المصرية  
العامة  
للمواصفات  
والجودة

EOS

• الهيئة  
العامة  
للمراقبة علي  
الصادرات  
والواردات

GOEIC

• المعهد  
القومي  
للقياس  
والمعايرة

NIS

• المعهد  
القومي  
للجودة

NQI

• المجلس  
الوطني  
للاعتداف

EGAC

# Quality Infra-Structure in Egypt

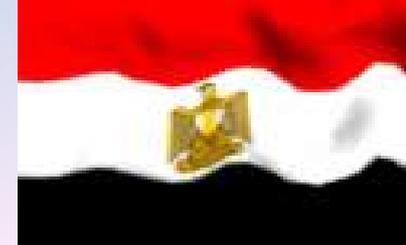

## National Quality Council

Accreditation  
EGAC

Metrology  
NIS

Standardization  
EOS

## Conformity Assessment Bodies

Cal/Test

Certification

Inspection

Medical

Proficiency  
Testing

## Market Surveillance

Ministry of  
Agriculture

Ministry of Supply

Ministry of  
Trade and Industry

Ministry of Health

## Contribution in development of Quality Infrastructure

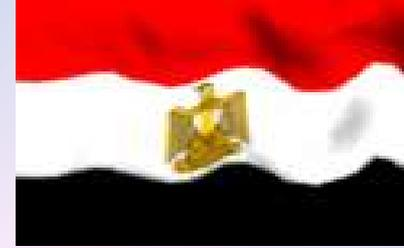

### Technical Regulations:

- EGAC shared effectively in supporting Quality infrastructure in Egypt through accreditation.
- EGAC succeeded to add a new technical regulation in the requirements of acceptance of products and services imported to Egypt that the importer should submit a certificate from a CAB accredited from a recognized accreditation body (Ministerial Decrees 991:2015/24:2016/43:2017)

### Metrology:

- EGAC shared in issuing and restructuring of the Egyptian Metrology law.

### Quality Legal Framework:

- EGAC shared in preparation of a draft proposal of the Unified Quality Law in Egypt.

## Contribution in development of Quality Infrastructure

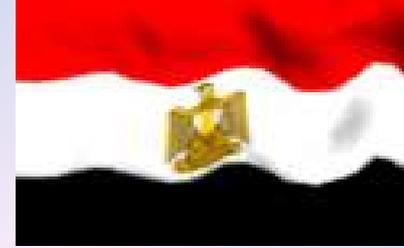

### Standards

- EGAC is sharing in ISO technical committees and mirror committees in the Egyptian Organization of Standardization.

### Halal Products

- EGAC is a BOD member of IHAF and heads the technical affairs committee of IHAF.

### Quality legal framework

- EGAC shared in preparation of the draft Unified Quality Law in Egypt.

- EGAC contacted Egyptian WTO representative *Sector of Trade agreements – Ministry of Trade and Industry* to support this work and be engaged together in this work.

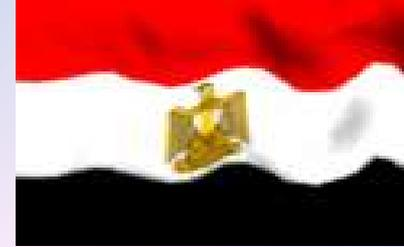

## Brief about EGAC

- EGAC has accredited about 500 CAB till now in different accreditation scopes (Testing / Calibration / Medical / Certification of MS / PTP / Product Certification / Forensic labs).
- EGAC accredited CABs in different countries besides Egypt like (Sudan / Niger / Saudi Arabia / Italy / Germany / Kuwait / India / Lebanon / UAE / Iraq / Jordan).
- EGAC carried out multiple accreditations on behalf of another accreditation bodies like UKAS, ANAB, FINAS, JAS-ANS and ACCREDIA.

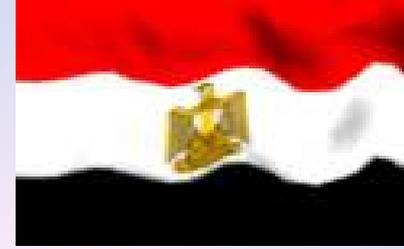

## Brief about EGAC

- EGAC through 3 twinning projects with EU could strengthen its accreditation capabilities and extend its scopes of accreditation by adding 3 new accreditation schemes (PTP, Product certification and certification of personnel).
- EGAC through the same projects established a marketing plan and carried out many workshops and seminars all over Egypt for awareness the industrial community of the importance and benefits of accreditation in the framework of quality infrastructure.

## Comparison between no. of CABS accredited in the past 3 years

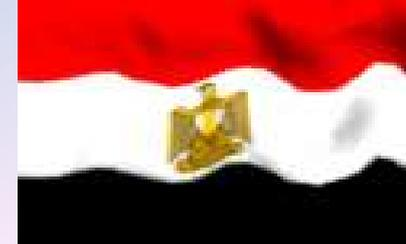

### Till end of 2017

Dept.	Testing	Cal.	Med.	Insp.	Cert.	PTP	Total
No. of acc. CABS	267	46	29	11	13	2	368

### Till end of 2018

Dept.	Testing	Cal.	Med.	Insp.	Cert.	PTP	Total
No. of acc. CABS	311	49	36	15	18	4	433

### Till end of 2019

Dept.	Testing	Cal.	Med.	Insp.	Cert.	PTP	Foren.	Prod.	Total
No. of acc. CABS	318	53	50	17	22	5	1	1	467



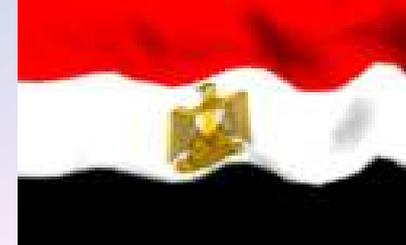

### No. of acc. CABs in 2019 in 2019

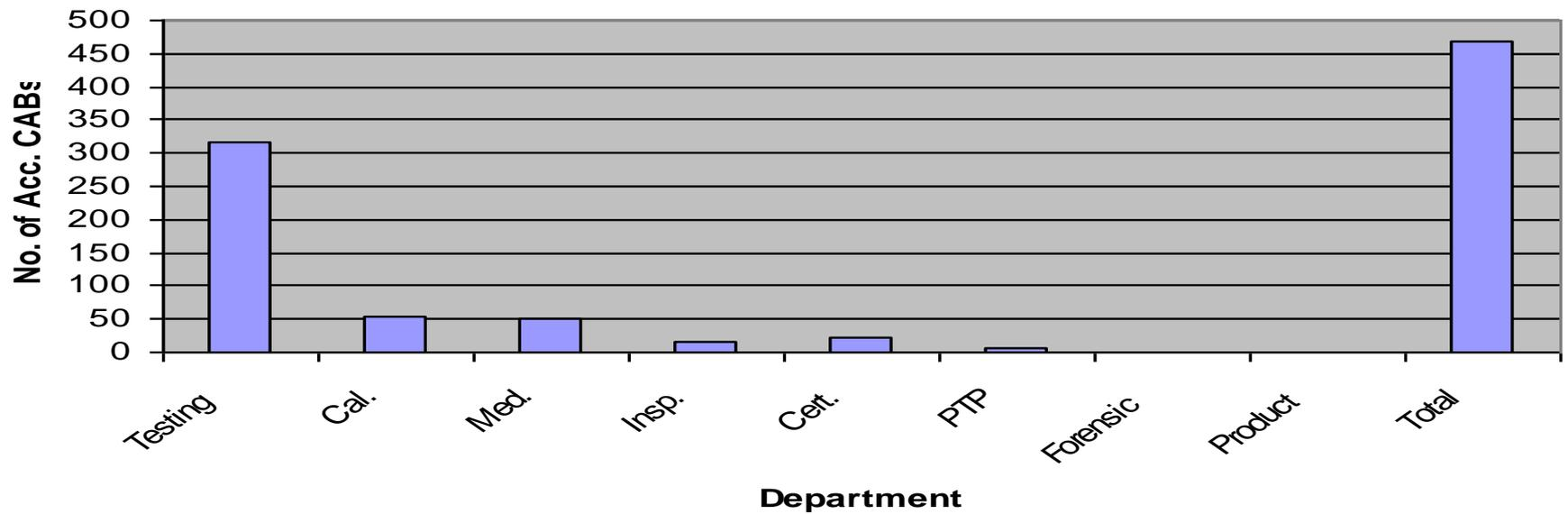

■ No. of acc. CABs in 2019

Dept.	Testing	Cal.	Med.	Insp.	Cert.	PTP	Forensic	Product	Total
No. of acc. CABs in 2019	318	53	50	17	22	5	1	1	467

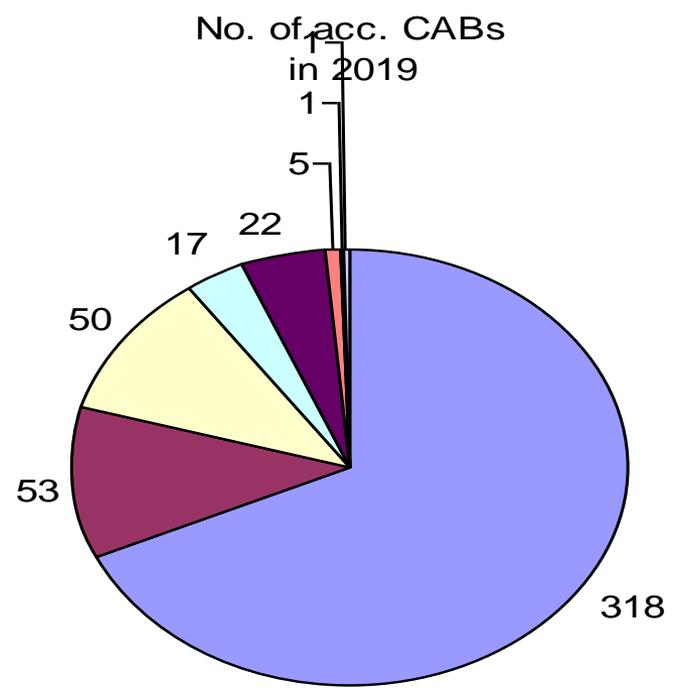
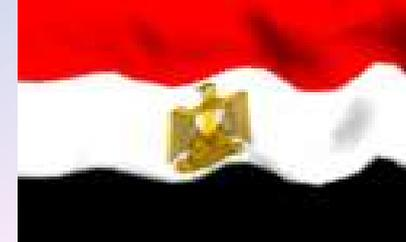

■ Testing 
 ■ Cal. 
 ■ Med. 
 ■ Insp. 
 ■ Cert. 
 ■ PTP 
 ■ Forensic 
 ■ Product

Dept.	Testing	Cal.	Med.	Insp.	Cert.	PTP	Forensic	Product	Total
No. of acc. CABs in 2019	318	53	50	17	22	5	1	1	467

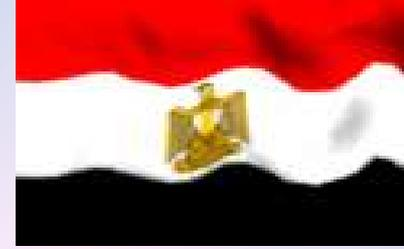

## **Brief about EGAC**

- **EGAC has signed MOUs with correspondent accreditation bodies in Africa, USA, Asia and Europe:**
  - ✓ **ENAO**
  - ✓ **BSCA**
  - ✓ **ANSI**
  - ✓ **NAH**
  - ✓ **CNAS**

**A new MOU will be signed with Brazilian Accreditation Body shortly.**

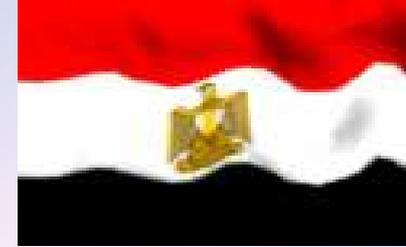

## Brief about EGAC

- **EGAC has accredited distinguished conformity assessment bodies of a unique scope like:**
  - ❖ **DNA Finger Print Laboratory - Forensic Medical Labs - Egyptian Forensic Medicine Authority - Ministry of Justice**  
**First accredited lab in Middle East and Africa in this scope.**
  - ❖ **Egyptian Doping Control Laboratory Ministry of Defense in determination of some Hematological Parameters.**  
**First accredited lab in Middle East in this scope , second after (South Africa).**

## EGAC future prospects

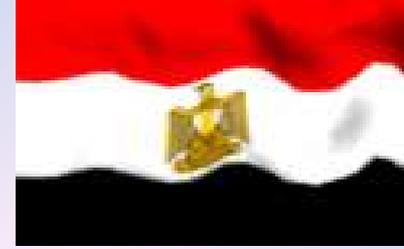

- 1. Maintains International and Regional recognition.**
- 2. Extension of recognition scopes to include validation and verification, product and persons certification.**
- 3. Support activities of International Halal Accreditation Forum IHAF with vision of recognition accreditation bodies in accreditation of HALAL certification.**

# شكراً لكم

